

Operating manual

Turning aid



Translation of the original operating manual

Revision: R04

Issue status: 02.2023

SAPEK GmbH
Drieschweidenweg 10
56648 Plaidt
Germany

info@sapek.de

<https://www.sapek.de>

Contents

1	General remarks	5
1.1	Information on this operating manual	5
1.2	Download this document:	5
1.3	Warnings / symbols	6
1.4	Limitation of liability	7
1.5	Copyright protection	7
1.6	Brands and trademarks:	7
1.7	Customer service / Manufacturer address	7
2	Safety	8
2.1	General remarks	8
2.2	Intended use	9
2.3	Foreseeable misuse	9
2.4	Personnel requirements	10
2.5	Operator's responsibilities	10
2.6	Personal protective equipment	11
3	Technical data	12
3.1	Overview	12
3.2	Dimensions	12
3.3	Dimension of the wall sections	12
3.4	Name plate / marking	13
3.5	EG Declaration of Conformity	14
4	Assembly and function	15
4.1	Overview	15
4.2	Functional description	16
5	Transport, storage, packaging	17
5.1	Symbols / markings on the turning aid	17
5.2	Transport	17
6	Installation, assembly and use	18
6.1	Installation site requirements	18
6.2	Surrounding area conditions	18
6.3	Setting up the turning aid on the construction site	19
6.4	Hydraulic rebound protection	20
6.4.1	Basic throttle valve setting:	22
6.5	Turning high walls	23
6.5.1	Delivery:	23

6.5.2	Lifting wall sections into position	24
6.5.3	Turning the wall section	26
6.6	Turning back the turning aid	29
6.7	Preparing the turning aid for transport.....	30
7	Maintenance, cleaning, service	31
7.1	Changing hydraulic fluid (possibly HVLP 46)	32
7.2	Testing hydraulic hose lines	32
7.3	Changing hydraulic hose lines	33
8	Disassembly and disposal	34
8.1	Safety	34
8.2	Disassembly	34
8.3	Disposal	34
9	Spare parts list	35

1 General remarks

1.1 Information on this operating manual

This operating manual contains important information on handling the turning aid during transport, use, maintenance and care as well as its disassembly and disposal.

For the documentation on the accessories, please refer to the separately enclosed documents.

For the safe, correct and economical work on and with the turning aid, compliance with all specified warnings and instructions is required.

Observing these helps avoiding hazards, reducing repair costs and downtimes and increasing the reliability and service life of the turning aid.

In addition, the occupational health and safety regulations and general safety regulations applicable to the place of work must be complied with.

Read the operating manual carefully before commencing any work! It is an integral part of the product and must be kept in the immediate vicinity of the turning aid and accessible to the staff at all times.



Before use, you must have read and understood the operating manual and the safety instructions contained therein.

1.2 Download this document:

The operating manual for the turning aid can be downloaded free of charge as a PDF file from the following link:

<http://abi-beton.de/downloads>

1.3 Warnings / symbols

The warnings used in this operating manual are introduced by signal words that express the extent of the hazard.

Furthermore, the warning symbol indicates the type of hazard.

The following warnings are used in this operating manual:



⚠ DANGER	
	Danger to life! Consequences of non-compliance...
	<ul style="list-style-type: none"> • Tips to avoid the danger



⚠ WARNING	
	Risk of injury! Consequences of non-compliance...
	<ul style="list-style-type: none"> • Tips to avoid the danger



⚠ CAUTION	
	Personal injury due to... Consequences of non-compliance...
	<ul style="list-style-type: none"> • Tips to avoid the danger



ATTENTION	
	Property damage due to... Consequences of non-compliance...
	<ul style="list-style-type: none"> • Tips to avoid the danger



NOTE	
	Note text... with additional information and tips to facilitate the described work step.

1.4 Limitation of liability

All information and notes in this operating manual have been compiled with due regard to the applicable standards and regulations and the current state of the art.

The manufacturer accepts no liability for personal injury, damage to property or operational malfunctions due to:

- improper use of the turning aid and its accessories
- improper operation and maintenance of the turning aid
- use with defective safety devices or improperly installed or non-functioning safety and protective devices
- poor monitoring of parts subject to wear and tear
- improperly performed repairs
- disasters caused by foreign bodies and force majeure

1.5 Copyright protection

This operating manual must be handled confidentially. It may only be used by the group of persons authorised to do so. The transfer to third parties may only take place with the written consent of the manufacturer.

All documents are protected within the meaning of copyright law.

The distribution and reproduction of documents, including excerpts, and the processing and publication of their contents are prohibited unless expressly permitted. Infringements are punishable by law and oblige to pay damages.

We reserve all rights to exercise industrial property rights.

1.6 Brands and trademarks:

The brands and product names mentioned in this document are trademarks or registered trademarks of their respective owners.

1.7 Customer service / Manufacturer address

SAPEK GmbH
Drieschweidenweg 10
56648 Plaidt
Germany

info@sapek.de

<https://www.sapek.de>

2 Safety

2.1 General remarks

This chapter warns of possible dangers when handling the turning aid. The hazard detection information contained herein is intended to allow for the safe and correct operation.



Be sure to read and observe this operating manual and in particular this chapter before using the appliance.

In addition to the safety instructions, the operating manual includes:

- a general product description
- notes on installation and transport
- the operating instructions
- maintenance and care instructions
- technical data
- disassembly and disposal

Always keep this operating manual and other documents at hand for your personnel, in the immediate vicinity of the turning aid.

Always observe all information, notes, instructions and guidance contained therein! Avoid accidents due to misuse!

All safety and hazard warnings on the turning aid must be kept in legible condition and renewed if necessary.

General safety instructions

- Only commence work with the turning aid after you have understood all operating and safety devices.
- Familiarise yourself with possible hazards of your work.
- Follow all protective measures described in the operating manual.
- Keep working areas and floors free of objects that can result in hazardous situations.
- Always use a tool suitable for the job when making adjustments or repairs.
- Do not make any unauthorised modifications to the turning aid.
- Never work with the turning aid if under the influence of medication or alcohol!

2.2 Intended use



The turning aid serves to hold and turn wall and double wall sections with a maximum weight of 10 tons.

The wall sections are turned by 90° with the aid of a crane. The turning aid has no drive of its own.

2.3 Foreseeable misuse

- Turning parts other than wall sections,
- exceeding the maximum load capacity,
- use of incorrect or unsuitable slings.

2.4 Personnel requirements



WARNING

Risk of injury due to insufficient qualification!

Incorrect handling can result in considerable injury. All activities must only be performed by qualified and instructed personnel.

- Personnel to be trained may only work with the appliance when under the constant supervision of an experienced person.

The client or the turning aid user commissioned by the client undertakes to instruct all personnel who are commissioned to work on the turning aid before commencing work,

- to observe the basic regulations on occupational safety and accident prevention,
- to read the chapter on safety and warnings in the operating manual, and
- to observe the chapter on operation.

2.5 Operator's responsibilities

The operator is obliged to only allow personnel to work on the machine

- who are familiar with the basic regulations on occupational safety and accident prevention and who have been instructed in the handling of the machine,
- who have read and understood the chapter on safety and the warnings in this operating manual and who have confirmed this by their signature, and
- who have their safety knowledge for such work checked at regular intervals.

2.6 Personal protective equipment

The following personal protective equipment must be worn at a minimum when working with the turning aid:



Safety shoes

to protect the feet from falling objects



Gloves

to protect hands and fingers



Helmet

to protect against head injuries

3 Technical data

3.1 Overview

Serial no.: (consecutive):	1001
YOM (see name plate):	2020
Max. load capacity:	10 tons
Dead weight:	approx. 1.3 tons

3.2 Dimensions

Length approx.:	3,000mm
Width approx.:	2,250mm
Height approx.:	2,300mm
Turning angle:	90°

3.3 Dimension of the wall sections

Permissible dimensions of the wall sections to be turned:

Min. length:	800mm
Max. length:	3.250mm
Max. height:	12.500mm
Max. thickness:	450mm
Max. weight:	10 tons

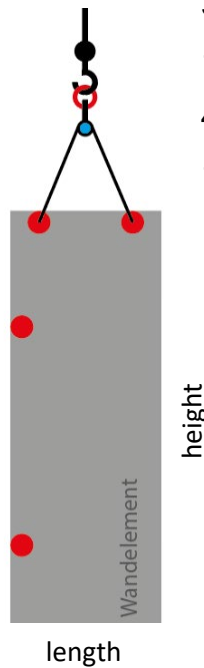

3.4 Name plate / marking

SAPEK GmbH
 Drieschweidenweg 10
 56648 Plaidt Germany

info@sapek.de
<https://www.sapek.de>

Drehhilfe

Fabr. Nr.: 1001
 Baujahr: 2020

Eigengewicht: 1,3 t
 max. Traglast: 10 t

Drehhilfe	Turning aid
Fabr Nr.:	Serial no.:
Baujahr:	YOM:
Eigengewicht:	Dead weight:
max Traglast:	Max. load capacity:

This name plate is located on the side of the turning aid.



A valid DGUV inspection plate is located on the frame.

3.5 EG Declaration of Conformity

EG Declaration of Conformity

Declaration of conformity – Déclaration de conformité
In accordance with the EC Machinery Directive 2006/42/EC of 17 May 2006, Annex II A

Turning aid
Serial no. 1001 -



The company

SAPEK GmbH
Drieschweidenweg 10
56648 Plaidt
Germany

as manufacturer hereby declares that the machine, due to its design and construction, complies with the relevant provisions of the EC Machinery Directive.

The person authorised for compiling the technical documentation in accordance with the Machinery Directive is: Mr Andre Hamornyik

Relevant directives:

EC Machinery Directive: 2006/42/EC

Mainly applied harmonised European standards:

- DIN EN ISO 12100:2011 – Safety of machinery – General principles for design – Risk assessment and risk reduction

For a detailed list of standards, see the technical documentation.

Date:

Manufacturer signature

4 Assembly and function

4.1 Overview

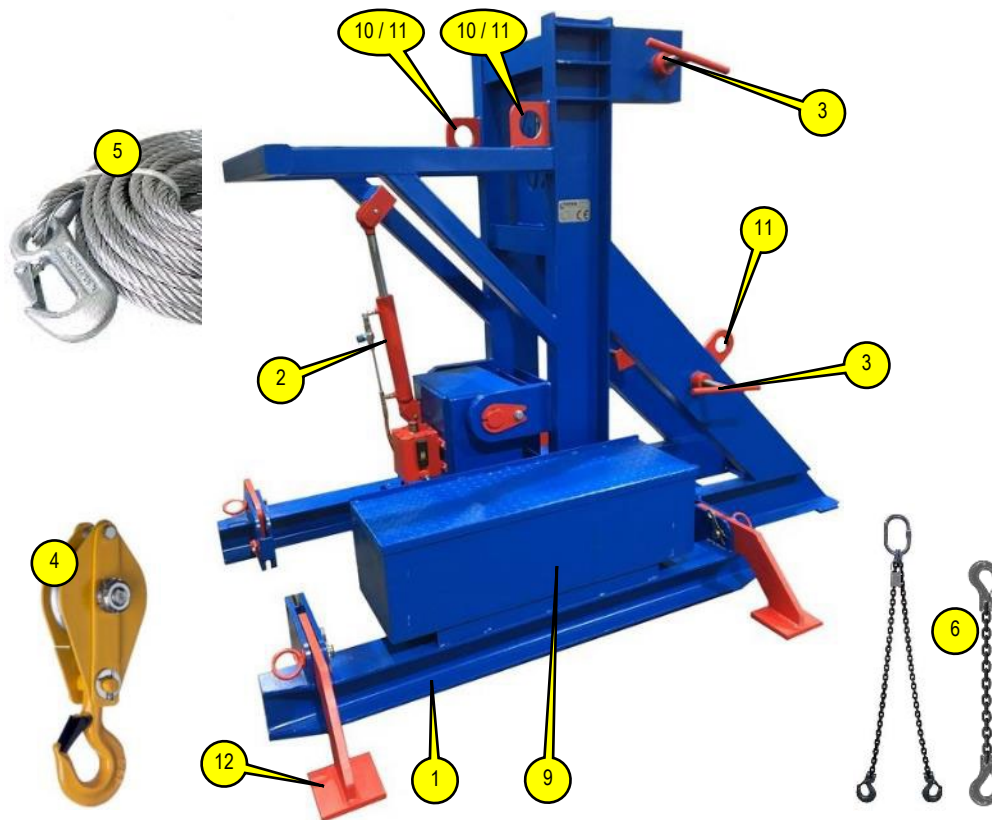

The supplied set-up device includes the following parts:

1. turning aid / frame construction
2. damping device / hydraulic cylinder
3. clamping screw 4x (36 mm, coarse + one spare spindle)
4. deflection pulley – 10 t load capacity (fig. similar)
5. deflection rope, length 6 m (fig. similar)
6. 2-strand sling with one deflection (shackle) each and 2 m chain with 2 sling hooks (fig. similar)
7. 0.50 litres of hydraulic oil as a refilling reserve (in accessories box)
8. operating manual (in accessories box) 
9. accessories box
10. attachment point for turning back
11. attachment point for set-up
12. 4x supports
13. throttle valve

Before each use, the above components must be checked for their completeness and function on site. Missing or defective parts must be verified with the owner before use.

After use, the undamaged and complete set-up device must be prepared for collection.

Damaged or missing parts must be reported to the owner.



4.2 Functional description

The wall sections that are horizontally delivered by truck are inserted into the turning aid and turned by 90° into a vertical position. This way, they can be integrated into a structure without taking damage.

5 Transport, storage, packaging

5.1 Symbols / markings on the turning aid

The following symbols or markings can be found on the appliance. They must always be observed during transport.

<p>Centre of gravity Schwerpunkt</p>		<p>This symbol indicates the position of the centre of gravity. The symbol is only used if the centre of gravity is not in the centre.</p>
<p>Sling here Anschlagpunkt</p>		<p>Only attach slings to the positions marked with this symbol. The attachment points are marked in colour.</p>

5.2 Transport



NOTE
<ul style="list-style-type: none"> • Transport may only be performed by instructed and qualified personnel. • Attach transport securing devices and handling devices at the intended points only. • Secure against slipping. • Do not set down in a jerky manner and avoid impacts. • System parts and accessories must be transported carefully.

The transport must be performed exclusively by crane. Observe the weight indications on the appliance and in this operating manual as well as the affixed symbols.

6 Installation, assembly and use

6.1 Installation site requirements

Set up on a level and stable surface. The technical data in chap. 3 must be observed.

6.2 Surrounding area conditions

The following conditions for the surrounding area must be observed.

Property	Value	Unit
Nominal illuminance (En)	300	lx
Recommended temperature range	-10 to +60	°C

6.3 Setting up the turning aid on the construction site

1. Unload the turning aid from the truck with a suitable crane. Use the attachment points on the frame for this purpose.
2. Set up the turning aid on an appropriately large, level surface with sufficient load capacity.
3. Unfold 4x supports and secure with bolts.

ATTENTION! Always secure bolts with safety cotter pins!

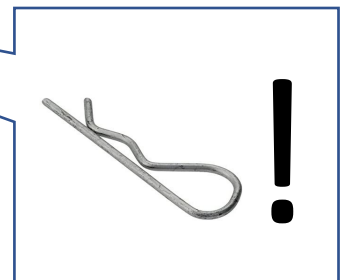
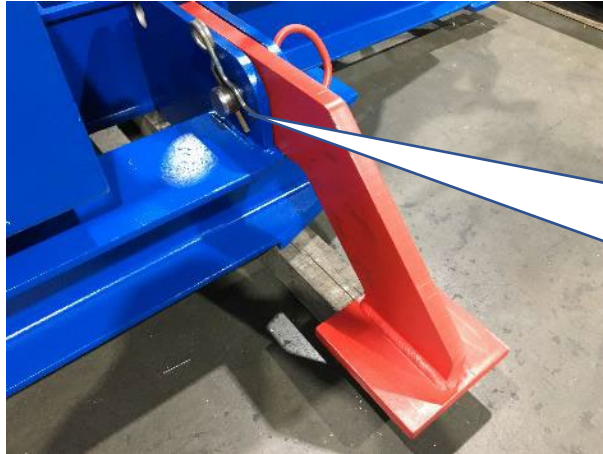

4. Align the turning aid with a spirit level. If required, level uneven floors with suitable underlays.
5. Remove the lock pins (transport securing device) for the turning process and insert them into the intended holder.

ATTENTION! Always secure bolts with safety cotter pins!

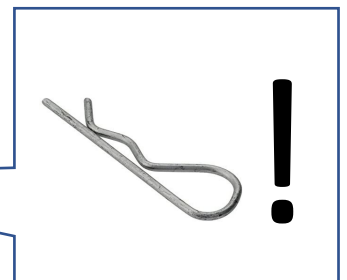

6. The turning aid is ready for use

6.4 Hydraulic rebound protection



DANGER

Danger due to rebound of the turning aid

Possibility of serious injuries if the turning aid snaps back.

- Always check the oil level before use.
Never work with too little oil.

To prevent the turning aid from rebounding in an uncontrolled manner after the concrete element has been removed, it is equipped with a hydraulic cylinder.

This hydraulic cylinder brakes the appliance when it swings back. The throttle valve is preset and must never be adjusted.



DANGER

Severe to fatal injuries during erecting process

Wall sections suddenly changing direction during the erecting movement.

During the erecting process, the hydraulic cylinder has NO effect.

- Use the crane to erect the wall sections slowly and carefully.
- When turning the wall sections, always keep a sufficient distance from the turning aid.
- Keep unauthorised persons out of the area of the turning aid.



throttle valve



The hydraulic tank must always be filled to approx. $\frac{3}{4}$.



ATTENTION

Property damage due to incorrectly filled oil or damaged parts

Possibility of the turning aid turning over in an uncontrolled manner or damage to the hydraulics.

- BEFORE each use:
Check oil level – only use hydraulic oil HLP 46, check all components (cylinders, tank, hoses...) for damage

6.4.1 Basic throttle valve setting:

The throttle valve slows down the movement when turning back the turning aid. When the wall is erected, the valve has no effect.

The valve does NOT have to be opened during the erecting process!

Clockwise rotation – CLOSED:

- High braking effect.
- Reduces the flow, turning back becomes slower.

Counter-clockwise rotation – OPEN:

- Little to NO braking effect.
- Increases the flow, turning back becomes faster.



DANGER

Severe to fatal injuries.

Possibility of the turning aid turning over in an uncontrolled manner.

- Valve adjustments must be performed by appropriately instructed persons only.
- Always use a crane for turning.

If the valve has been adjusted, proceed as follows, provided the frame is in the turning position:

1. Close the valve completely.
2. Open the valve 2-3 turns.
3. Carefully check the adjustment – turn back the turning aid (using a crane, there must be no persons in the turning aid area)
4. Correct the setting if required

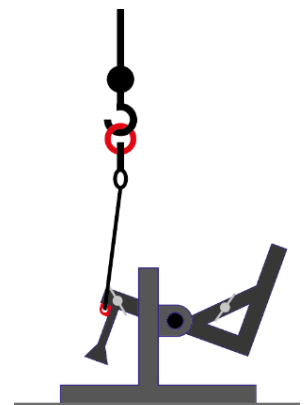

6.5 Turning high walls

Requirements:

The turning aid has been set up correctly and all parts are present and undamaged.

The hydraulic system is in good repair and correctly adjusted.

6.5.1 Delivery:

The double wall sections are delivered on the truck, standing sideways (90° to the installation position) in the transport rack.

There are transport anchors in the top and sides of the double wall sections.

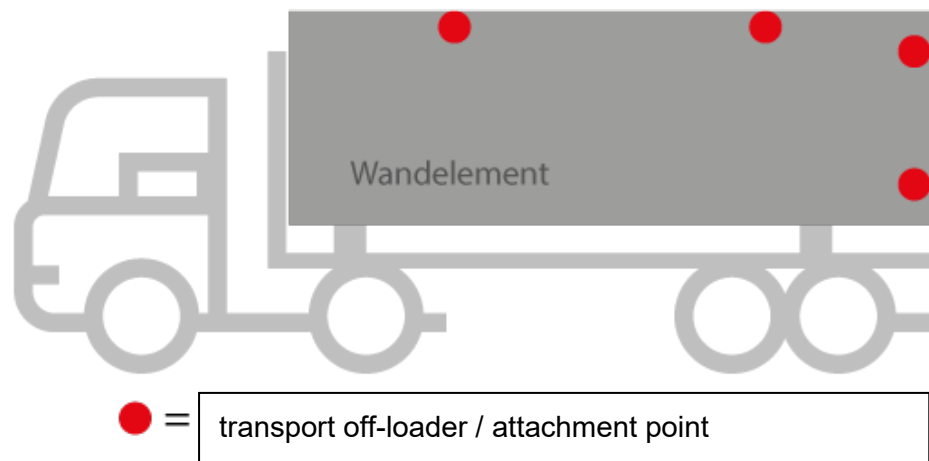

DANGER

Severe to fatal injuries due to inappropriate slings

Included in the scope of delivery of the turning aid is a 2-strand sling with a deflection (shackle) and 2 m of chain with 2 sling hooks.

For wall weights < 5 tons, 2-strand sling chains are required.

6.5.2 Lifting wall sections into position



! GEFAHR

Severe to fatal injuries

Possibility of the turning aid or wall section turning over.

- The wall may only be lifted by appropriately instructed persons.
- Never use the deflection pulley when lifting the wall from the truck.
- Only use sling chains!

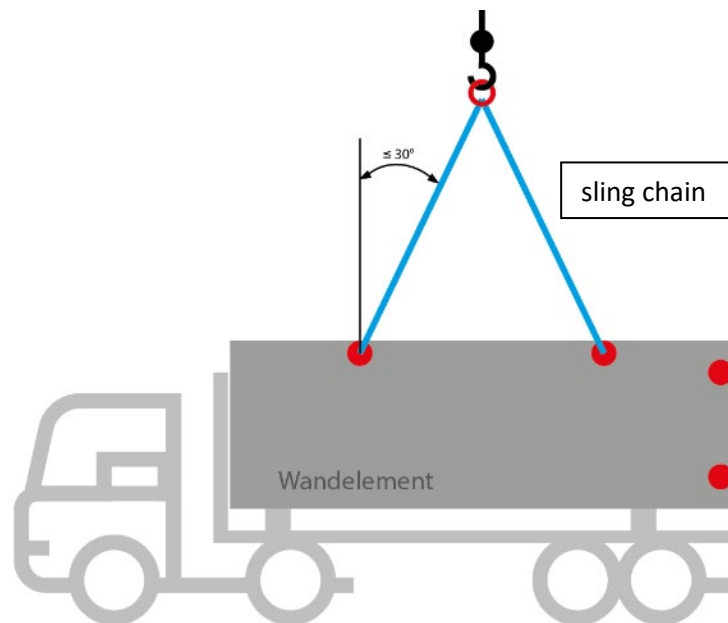

1. Attach the wall section to the transport off-loaders. Use sling chain.

ATTENTION! The supplied deflection pulley must not be used.

2. If required, loosen the wall section at the frame.

3. Lift the wall section out of the truck frame, taking into account the maximum permissible diagonal pull.

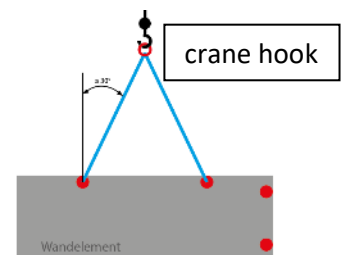

4. Carefully place the wall section in the turning aid.

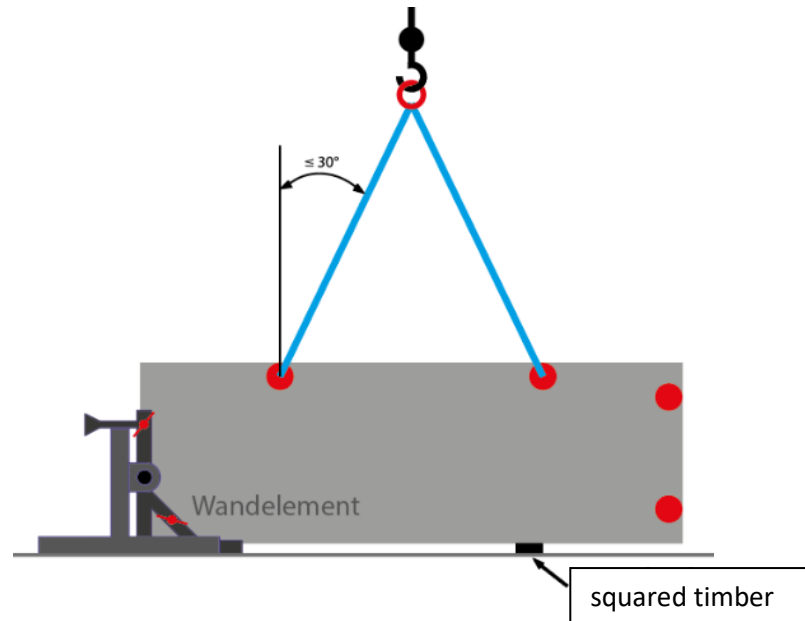

5. Place squared timber under the wall section to compensate for height.

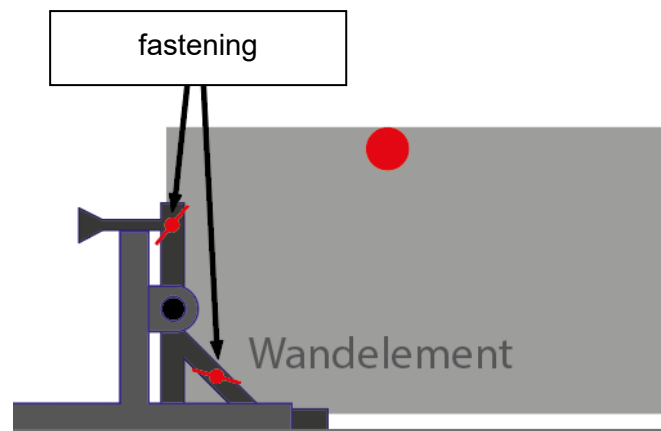

ATTENTION



Damage to the fastening possible

Possibility of bending or breaking off the fastening when using tools (e.g. hammers).

- Only tighten the fastening by hand.
- If required, lightly grease the thread of the fastening.

6. Clamp the wall section from both sides using the four fastenings.

7. Remove the sling chain from the wall section.

6.5.3 Turning the wall section

1. Attach the deflection pulley (rope compensation) to the crane.
2. Attach the rope of the deflection pulley to the two attachment points of the wall section.

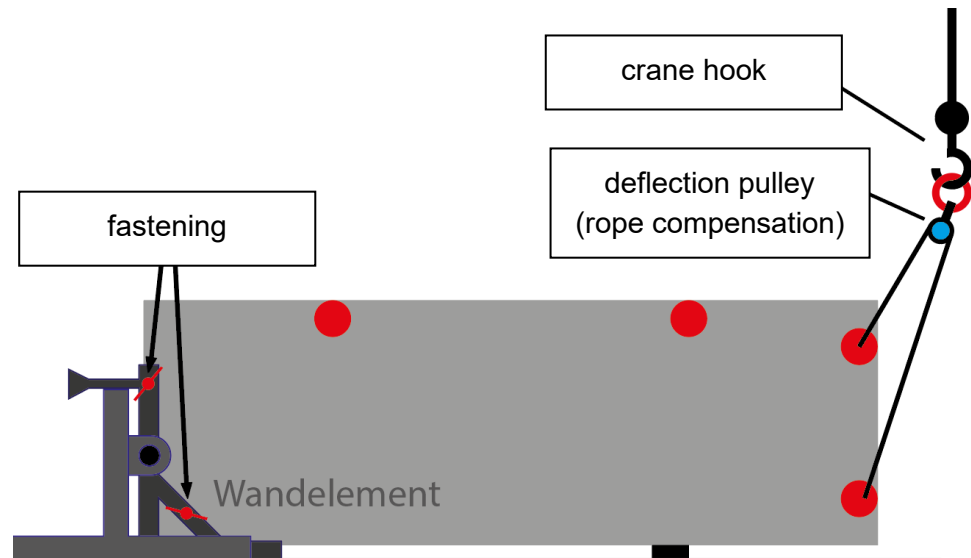



! DANGER

Severe to fatal injuries!

Possibility of severe to fatal injuries due to swinging, overturning or falling loads.

- When turning the wall sections, always keep a sufficient distance from the turning aid.
- Keep unauthorised persons out of the area of the turning aid.

3. Lift the wall section carefully.

ATTENTION! Always keep an eye on the fastening when lifting. If the fastening needs to be retightened, the load must be lowered beforehand!

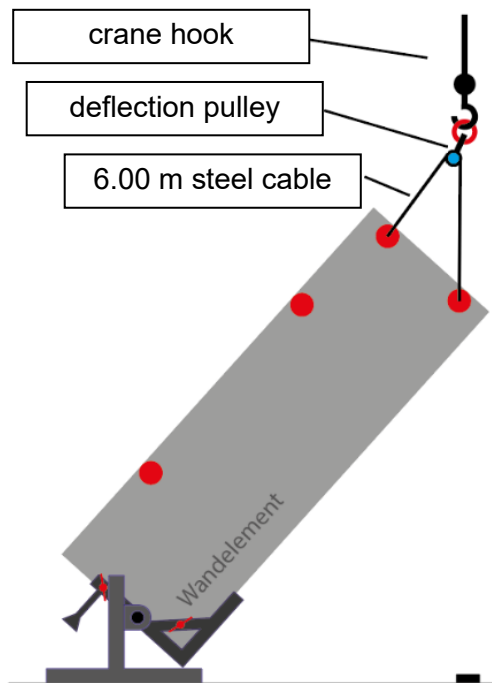

! DANGER



Severe to fatal injuries during erecting process

Wall sections suddenly changing direction during the erecting movement.

During the erecting process, the hydraulic cylinder has NO effect.

- Use the crane to erect the wall sections slowly and carefully.
- When turning the wall sections, always keep a sufficient distance from the turning aid.
- Keep unauthorised persons out of the area of the turning aid.

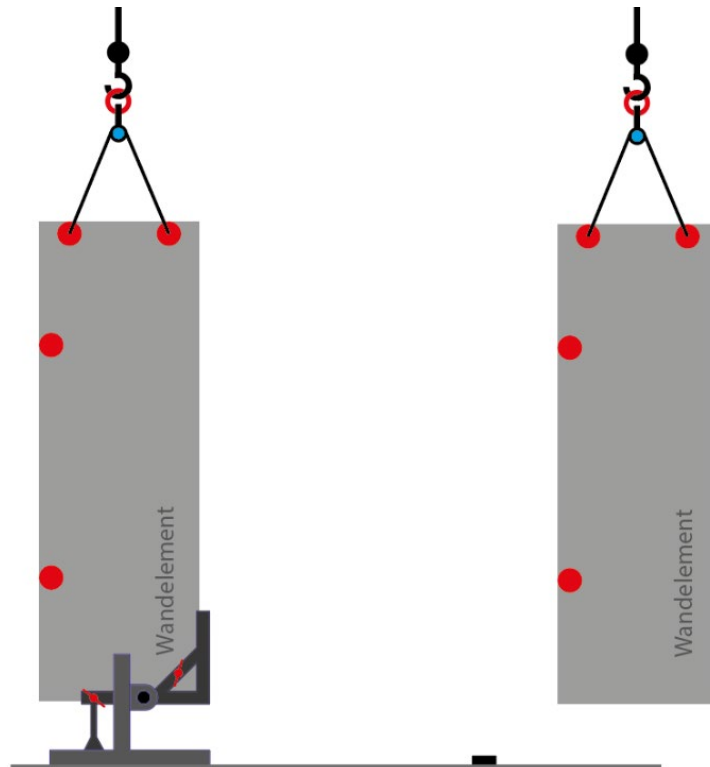

4. Bring the wall section into an upright position.

ATTENTION! When loosening the fastening, be aware that the set-up device can swing back in an uncontrolled manner and injure the employee.

5. Carefully loosen 4x fastening.

6. Lift the wall section slowly.



! DANGER

Severe to fatal injuries during erecting process

Possibility of sudden change of direction or skew position.

- Use the crane to erect the wall sections slowly and carefully.
- Always observe the centre of gravity by all means.
- When turning the wall sections, always keep a sufficient distance from the turning aid.
- Keep unauthorised persons out of the area of the turning aid.

NOTE

If the centre of gravity of the element is not in their vertical axis of symmetry, it will hang askew. This can NOT be compensated for by the deflection pulley.

6.6 Turning back the turning aid



DANGER

Severe to fatal injuries!

Possibility of severe to fatal injuries due to the turning aid swinging or overturning.

- Always use the crane to turn back the turning aid.
- Keep unauthorised persons out of the area of the turning aid.

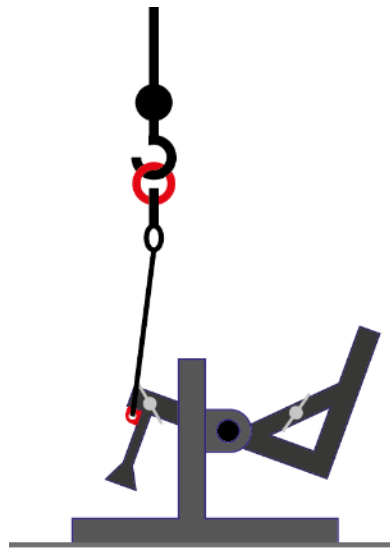

After successfully turning the wall section, the turning aid must be carefully turned back. This must only be done with the aid of the crane and never by hand!

1. Attach the sling chain to the eye (see figure)
2. Carefully turn back the turning aid with the crane.

The installed hydraulic cylinder must dampen the swing-back. If this is not the case, please notify the company immediately:

SAPEK GmbH
Drieschweidenweg 10
56648 Plaidt
Germany

info@sapek.de
<https://www.sapek.de>

6.7 Preparing the turning aid for transport

1. Swivel the turning aid back to its home position.
2. Insert the locking bolt (transport securing device) for the transport process.

ATTENTION! Always secure bolts with safety cotter pins!



3. Fold 4x supports and secure with bolts.

ATTENTION! Always secure bolts with safety cotter pins!

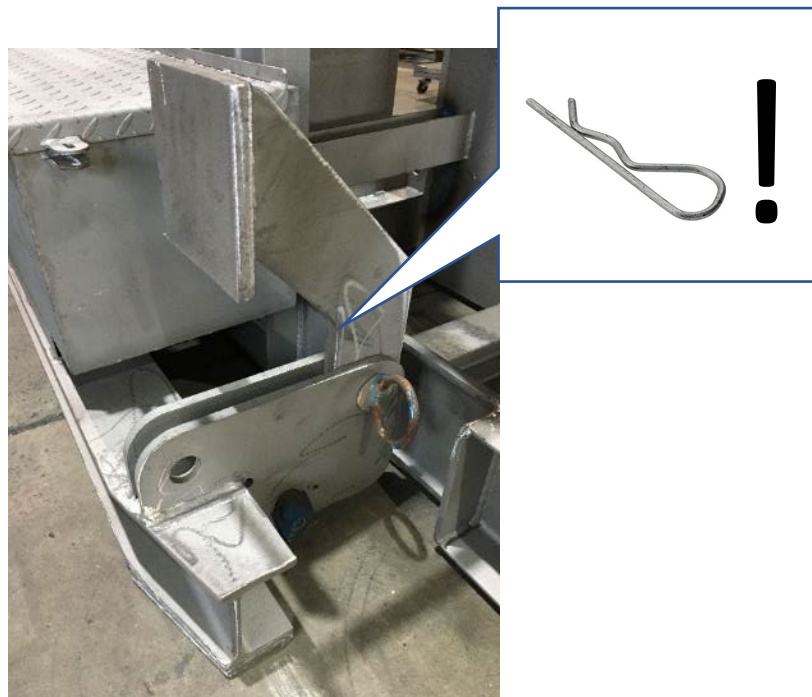

4. Load the turning aid on the transport vehicle with a suitable crane. Use the attachment point on the frame for this purpose.
5. Secure the turning aid on the vehicle using the attachment points on the frame.
6. Check the accessories box for completeness.

7 Maintenance, cleaning, service



WARNING

Risk of injury due to incorrect maintenance

- Perform the specified maintenance work in due time.
- Maintenance, inspection and repair work may only be performed by personnel with the appropriate qualifications.
- If screw connections have to be loosened during maintenance, inspection or repair, tighten them again firmly after completing the work (see tightening torques of the screw connections in the supplier instructions of the component manufacturers) and check the screws for tightness.
- After completion of the maintenance, inspection and repair work, the protective device must be checked for correct function.

Danger due to contact with hydraulic fluid!

The following measures must be taken after contact with hydraulic fluid:

- After skin contact: After contact with skin, wash immediately with plenty of soap and water. Remove contaminated clothing immediately and remove safely. Consult a doctor in case of skin irritation.
- After eye contact: In case of contact with eyes, rinse immediately with running water for 10–15 minutes with the eyelids open. Then consult an eye doctor.
- If swallowed: Do not induce vomiting. Call a doctor immediately.

In case of foreseeable contact with hydraulic fluid (maintenance, repair), wear protective gloves!



GEFAHR

Danger due to high-pressure penetration of hydraulic fluid into the body (injection)!

Injuries caused by injection of hydraulic fluid must be treated immediately and must not be treated like simple cuts!

- Pressurised media can cause serious injuries.
- They can emerge almost invisibly from a pin-sized hole, pierce the skin and penetrate the body.
- If there is an accident involving penetration of the medium into the body, seek medical attention immediately.
- Never touch a pressurised hydraulic hose line and keep away from the danger zone (fitting) when checking a hydraulic hose line!
- When testing pressurised hoses, keep away from danger zones and always wear safety goggles!



When replacing defective parts, use original parts approved by the manufacturer only. The exact designations can be found in the supplied spare and wear parts lists. We are not liable for damages resulting from the use of non-original parts or special accessories.

The tilting device requires a minimum of maintenance when cleaned daily.

However, the following points must be performed daily or as required to ensure proper functioning.

- Checking the turning aid for damage.
- Visual inspection of the hydraulic parts (hoses, cylinder, tank...)
- Cleaning the turning aid.
- Greasing the threaded spindles of the fastening.
- Lubricating rod ends on hydraulic cylinders.

7.1 Changing hydraulic fluid (possibly HVLP 46)

When changing the hydraulic fluid, proceed as follows:

- Remove liquids from cylinders, reservoirs and pipes that do not drain properly.
- Wipe out, vacuum or pump out any oil remaining in the tank.
- Wipe out the tank with a lint-free cloth and remove rust and loose paint (if technically possible).
- Refill the system with new oil and be sure to vent elevated parts.
- Restart the system and check for proper operation.

7.2 Testing hydraulic hose lines

- Damaged, cracked, cut or abraded hose outer layer
- Exposed pressure carrier
- Cracked, damaged or corroded fittings
- Leakage at the fitting
- Hose sweats near the fitting
- Kinked, crushed, compressed or twisted hose
- Hard, stiff, cracked or charred hose
- Blistered, soft, decomposed or loose hose outer layer

ACHTUNG



Basically:

Hose lines that show external damage, signs of leakage or generally contradict the directives for laying hose lines must be replaced immediately.

- Do not repair hydraulic hose lines!

7.3 Changing hydraulic hose lines

Hydraulic hoses are subject to a natural ageing process and are therefore limited in their service life. The conditions of use and the hose qualities used have a considerable influence on the service life of a hose line.

As a rule:

Requirement	Recommended replacement intervals
Normal requirement	6 years (operating time incl. max. 2 years storage time)
Increased demand e.g. due to: increased operating times (e.g. multi-shift operation), or short machine cycle times or pressure pulses, strong external and internal influences (caused by the medium), which greatly reduce the service life of the hose line	2 years (operating time)

8 Disassembly and disposal

8.1 Safety



WARNING

Risk of injury due to incorrect disassembly

- Have disassembly work performed by qualified personnel only

8.2 Disassembly

For all disassembly and disposal work, the locally applicable occupational health and safety as well as environmental protection regulations must be observed.

1. Clean the turning aid and remove residues of production materials.
2. Remove all operating and auxiliary materials (oils, greases, etc.) and dispose of them in an environmentally friendly manner.
3. Disassemble the turning aid and separate recyclable materials.

8.3 Disposal

Separate steel scrap, plastics, electronic scrap, cable remnants, etc. and send them for recycling or dispose of them correctly.

9 Spare parts list

Designation	NO.
Pivoted joint + bolt	10020915
Trapezoidal spindle + handle	50022876
Pressing plate	10020916
Trapezoid nut	50022874
Brake cylinder	10020090